

ICP - Mass Spectrometry

Advantages of a Novel Interface Design for NexION 5000 ICP-MS

Authors:

Hamid R. Badiei

William Fisher

Serguei Savtchenko

Ewa Pruszkowski

Andrew Icasiano

PerkinElmer, Inc.
Woodbridge, Canada

Uncompromised Design for Uncompromised Performance

The Art of Interface Design

The interface region between an inductively coupled plasma source and a mass spectrometer is considered key in determining the overall performance characteristics of an ICP-MS system, including those related to sensitivity, mass bias, as well as matrix-dependent response.

The development of a two-cone, differentially pumped interface by Douglas and French^{1,2}, based on molecular beam techniques originally developed by Campargue³, led to the introduction of the first commercially available ICP-MS by PerkinElmer-SCIEX in 1983. The differentially pumped interface offered several advantages over those attempted previously⁴, most notably on the ability to use a larger sampling orifice (>1 mm), which minimized cone clogging when analyzing samples with high total dissolved solids (TDS). In addition, the composition of the plasma through the orifice was essentially the same as the bulk plasma due to a relatively smaller orifice boundary layer compared to its cross-section area. A second cone, namely the skimmer, situated in the supersonic expansion region behind the sampler, allowed the centerline flow of plasma into the downstream ion optics of the mass spectrometer.

Despite the success of ICP-MS as the fastest growing trace-element technique, the interface design of ICP-MS is still considered an area of focus for further improvement. Early work to characterize the two-cone interface design revealed that the ion transmission efficiency through the interface is primarily limited by space-charge effects in the region behind the skimmer cone where ambipolar diffusion becomes dominant.⁵ Highly mobile electrons diffuse away from the beam and form a charge separation zone with an electron sheath at the inner surface of the skimmer. The polarization field in this zone is somewhat offset by the slower diffusion of positive ions in order of their mobility, leaving a net-positive charge on the axis of the ion beam. Strong defocusing of the ion beam, significant mass bias against low-mass ions, and susceptibility to matrix effects are direct consequences of space-charge effects.⁶

Strategies to Overcome Space-Charge Effects

Different approaches have been adopted to minimize the adverse effect of space charge, and to improve ion transmission efficiency through the ICP-MS interface. The majority include those utilizing strong, negative electric fields originating from a set of extraction cones or lenses situated immediately behind the skimmer cone. The rationale is that a strong negative field behind the skimmer would accelerate the ions toward the downstream ion optics and reduce the local ion number density before beam neutrality is lost, and space charge has taken effect to defocus the beam and limit the transmission. This is in line with the relationship between the magnitude of the space charge, $\Delta\Phi$, defined as the extent of the charge separation with unit of volts, and the total ion current, I , in amperes, and ion velocity, v , in cm/s. Other terms in Eq. 1 are E_r , total radial voltage drop, r , ion beam radius, and j , current density.

$$\Delta\Phi = \int_0^a E_r dr = \int_0^a \frac{2\pi r j}{v} dr \frac{9 \times 10^{11} I}{v} \quad \text{Eq. 1}$$

However, accelerated ions must eventually decelerate prior to mass analysis by a quadrupole-based mass analyzer. Upon deceleration, the ion beam can again experience space charge and defocusing, unless downstream ion optics are designed in such way to counter the effect. Despite improved raw sensitivity, the extraction approach using metal cones and lenses is also susceptible to material sputtering through a direct interaction with the accelerated ion beam which mainly consists of argon ions. The consequence of such interaction is elevated chemical background levels for those elements that are the main constituents of the material used in construction of the cones and lenses as well as easily ionizable elements that are often present as surface contamination. That is perhaps one of the reasons why such ion extraction approaches force the operator to use cool plasma conditions in order to improve on the background equivalent concentration (BEC) levels for a number of key elements that are important for applications such as high-purity process chemicals analysis in semiconductor applications. However, a compromise to be made with non-robust conditions of cool plasma is the increase in matrix-dependent sensitivity and the mitigatory measures needed to counter these effects, such as matrix-matched calibration and standard addition.⁷ Furthermore, hard-to-ionize elements in a sample have to be analyzed separately in hot plasma conditions, which prolongs the total analysis time and requires more sample for analysis.

The Triple Cone Interface Design

A more effective approach to address space-charge effects in the interface region and improve ion transmission is to reduce the ion current through the interface and into the downstream ion optics. A patented Triple Cone Interface design based on this approach is currently utilized in NexION® ICP-MS systems where a hyper-skimmer cone re-skims the flow through the skimmer and improves the ion-to-gas ratio by further removing the neutrals that have undergone re-expansion behind the skimmer cone and reducing the gas load into the mass spectrometer.⁸ Figure 1 shows a contour

plot of argon mean free path through the Triple Cone Interface geometry generated using Direct Simulation Monte Carlo (DSMC). Knudsen numbers calculated based on the mean free path values indicate that this arrangement maintains extended charge neutrality and the flow through the hyper-skimmer cone remains to be in transitional regime. The reduction in the ion beam current is overcompensated by the improved transmission due to less space charge and overall improved sensitivity, especially for low mass ions, thus improving the overall mass bias of the ICP-MS system. Figure 2 shows the experimental measurements obtained for an ion beam profile 16.5 mm downstream of the hyper-skimmer cone using laser-induced fluorescence (LIF) of Ba ions.⁹ The full width at half maximum (FWHM) of the profile is roughly 2 mm. Considering that the hyper-skimmer orifice diameter is 1 mm, the extent of beam expansion due to space charge at such distance downstream of the orifice is significantly less than those reported in the literature for any two-cone interface geometry.^{10, 11}

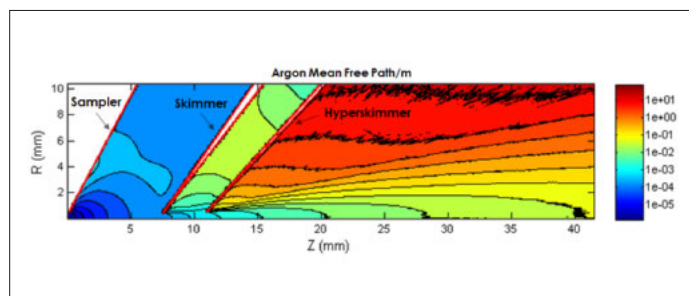

Figure 1. Contour profile of argon mean free path of the Triple Cone Interface geometry simulated using a Direct Simulation Monte Carlo (DSMC) model.

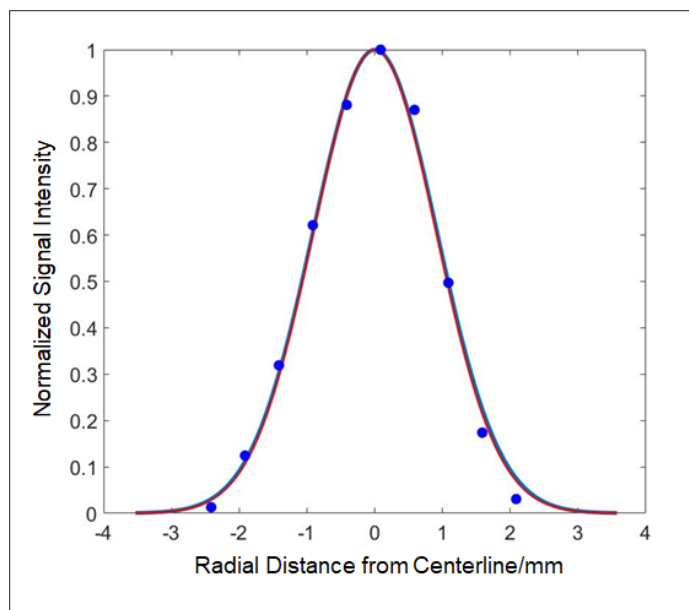

Figure 2. Width profile measured for the ion beam at 16.5 mm downstream of the hyper-skimmer orifice using laser induced fluorescence (LIF) of Ba ions.

Second-Generation Triple Cone Interface with OmniRing Technology

The motivation behind a new interface design for the NexION 5000 ICP-MS was to complement the already impressive four stages of mass selectivity of the system with improved sensitivity but without any compromise on background levels, while ensuring that the final design can meet a wide range of applications including those targeting low BECs and complex matrices. Consequently, the ICP-MS Research and Development Team at PerkinElmer focused on a design that targets both parameters in Eq. 1 to reduce space-charge effects and improve ion transmission. After simulating and testing a number of candidate designs, the team focused on a design that included reduced ion current and programmable ion velocity through a proprietary technology called OmniRing™.

Figure 3 shows a cut-out of the solid geometry model of the final design. OmniRing technology is situated directly behind the hyper-skimmer cone, and together they make an easily accessible plug-and-play assembly. The simplicity of the OmniRing design is in contrast to other designs where a rather complex assembly of cones and lenses are stacked directly in line of sight of the ion beam to accelerate the ions. Conversely, OmniRing is a single-piece design that is as wide as the base of the hyper-skimmer cone, and is engineered not to come in direct contact with the beam. This is of high importance considering that the ion beam, consisting mostly of argon ions, can have sufficient energy in the accelerated region to sputter cone and lens material as well as surface contamination and contribute to elevated background levels. In other designs, higher plasma power exacerbates the problem. Furthermore, such surfaces are prone to contamination through deposition, especially for samples with heavy matrices, causing signal drift and increasing the need for frequent maintenance.

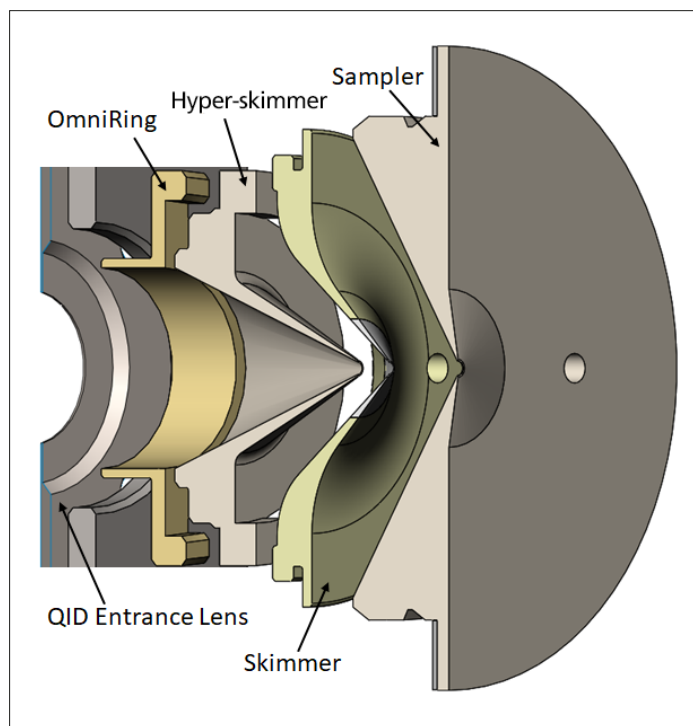

Figure 3. Triple Cone Interface geometry with OmniRing.

Figure 4 depicts an example of ion trajectory simulation through the interface, while taking into account space-charge effects as part of the calculations based on initial ion current measurements and experiments similar to those shown in Figure 2. The simulation results clearly demonstrate the effect of OmniRing behind the hyper-skimmer cone. As charge separation develops by diffusing electrons (blue trace), OmniRing accelerates the ions (green and red traces) through the interface with minimal expansion. Subsequently, the beam is refocused under the influence of a more positive voltage at the entrance of the Quadrupole Ion Deflector (QID). Experimental and simulation data also agree that the unique design of the interface ensures that the most probable energy (MPE) and ion kinetic energy (IKE) distribution of the ions entering the QID are essentially the same as those originating from the supersonic expansion process. This also guarantees that ion velocities through the downstream quadrupole (Q1) remain at a level where maximum abundance sensitivity can be realized. In addition, other issues, such as elevated background levels (e.g., due to ion sputtering) and space charge downstream of the interface, are significantly reduced.

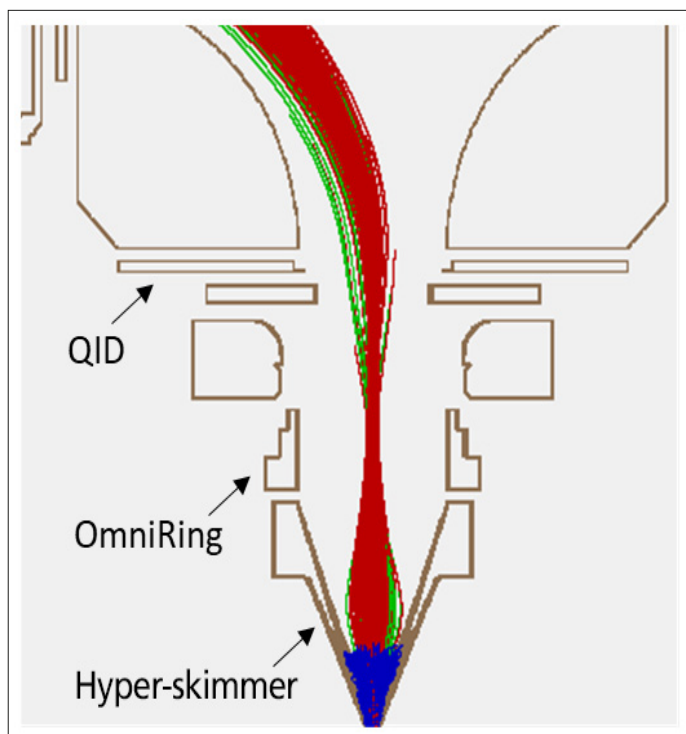

Figure 4. Example of ion trajectory simulation through the Triple Cone Interface with OmniRing.

The second-generation Triple Cone Interface with OmniRing not only extends the charge neutrality through the hyper-skimmer cone, but also provides the user with the ability to adjust ion acceleration and focusing for each element in the same method for best performance. This is expected because ion trajectories and the extent of space charge are not only mass dependent but can also be altered based on plasma operating conditions. The NexION 5000 platform offers a simple workflow in the instrument software to manage or customize different modes of operation of the system, including those related to the operation of OmniRing, depending on the application.

Impressive Sensitivity and Phenomenal Stability

Often, commercially available ICP-MS systems attempt to maximize sensitivity at the expense of instrument drift and increasing the susceptibility to contamination, especially with complex matrices. Higher sensitivities with such systems have always been ensued by a compromise on instrument noise and background levels. This prevents users from taking advantage of any improvement in BECs, especially when using robust plasma conditions, despite relatively higher apparent sensitivities. In contrast to such designs, the NexION 5000 ICP-MS is designed to provide sub-ppt BECs at maximum plasma power (1600 W) by both maximizing the sensitivity and maintaining low background levels. A main contributor to this performance characteristic is the design of the new Triple Cone Interface with OmniRing. Figure 5 provides an indication of average-sensitivity gains across the mass range with the new interface design. The data was acquired using a single set of operating conditions on multiple instruments and no attempt was made to optimize the systems for a particular mass range. Overall, the results showed sensitivity gains anywhere between 4-6 times compared to the baseline. Interestingly, this is on par with results predicted by the simulation results. Most notably, the background levels remained essentially unchanged between the two data sets, which confirms the initial design intent of the interface to maintain low background levels by reducing the ion current and controlling ion velocities entering the QID region.

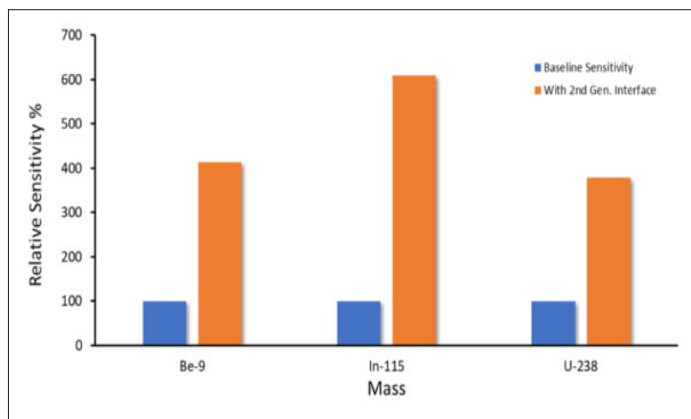

Figure 5. Relative sensitivity gain of the NexION 5000 ICP-MS with second-generation Triple Cone Interface and OmniRing vs. the baseline.

On signal stability and instrument drift, the NexION 5000 ICP-MS excels just as well, thanks to the design of the novel interface. Three stages of differential pumping, along with the simple design of OmniRing and essentially no surface in line of sight of ions into the mass spectrometer, has made the system exceptionally resilient to signal drift with complex matrices, such as those routinely analyzed in semiconductor applications and biological samples. An example for the latter is shown in Figure 6, for a 50x diluted pooled-blood sample spiked with 2 ppb of 15 elements. Normalized signal intensities (from the first data point) were plotted over 6.5 hours during a fast, multi-mode analysis that included Standard mode, MS/MS mode using NH_3 and O_2 as reaction gases as well as Mass Shift mode with O_2 used as a reaction gas for As analysis.

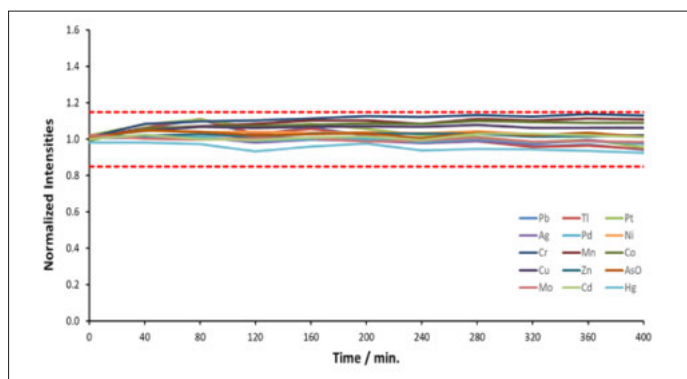

Figure 6. Example of signal stability for a multi-mode analysis of spiked pooled-blood samples.

For semiconductor applications using ICP-MS, harsh and corrosive chemicals, such as high-concentration acids, are often analyzed with limited or no dilution. The analysis of such fine chemicals is highly demanding given the level of BECs required for detection of ultra-trace levels of impurities. This explains why such samples are often preferred to be analyzed at the highest concentration possible, so that sample dilution does not limit the detectability of impurities in the original sample. The role that an ideal ICP-MS design plays in such applications is two-fold. Firstly, the system should be able to analyze such concentrated matrices in robust plasma conditions. This minimizes matrix effects and simplifies instrument calibration. Secondly, the system should not contribute to background levels of sought-for analytes through sputtering or simply the leaching of surface contaminants into the system. In both cases, an ideal interface design plays a major role. Figure 7 is an example of the performance of the NexION 5000 ICP-MS, utilizing the newly designed Triple Cone Interface with OmniRing. The sample is an undiluted 20% hydrochloric acid solution (TAMAPURE-AA-10, TAMA chemicals Co. Ltd., Kawasaki City, Japan) spiked to 50 ppt with a multi-element mix. The signal stability data for all analytes are normalized to the first data point. The plot shows excellent analyte signal stability in a multi-mode method that included MS/MS as well Mass Shift, in both cases using either NH_3 or O_2 as reaction gases. This, once again, confirms the initial design intent behind the second-generation Triple Cone Interface to maximize sensitivity without any compromise on stability and the robustness of the system.

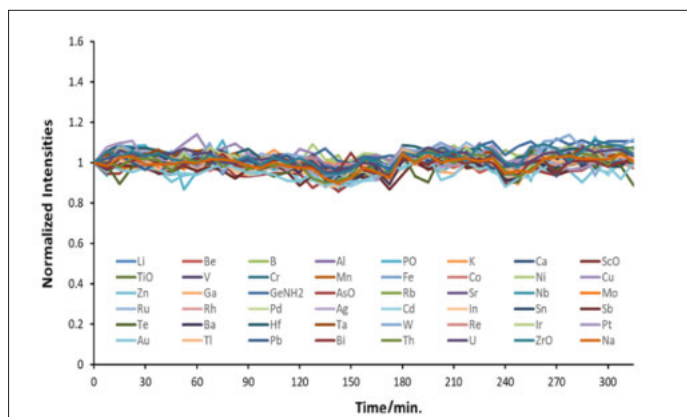

Figure 7. Example of signal stability for a multi-mode analysis of spiked, undiluted (20%) HCl.

Conclusion

The novel design of the second-generation Triple Cone Interface with OmniRing was developed specifically for the NexION 5000 ICP-MS with both sensitivity and stability in mind. The design builds on the Triple Cone Interface geometry and provides unique solutions to space-charge effects based on the simple yet highly effective OmniRing technology. The design focuses on many attributes of an ideal interface for ICP-MS, most notably, improved transmission by reducing the ion current while at the same time providing a controlled acceleration of the ions through the interface without transmitting high energy ions into the downstream ion optics. The result is much improved analyte signal intensities without the cost of elevated background levels. The ability to analyze complex matrices at sub-ppt BECs and with robust plasma conditions is a direct consequence of the design of this novel interface. In addition to high sensitivity, the interface design significantly contributes to the unmatched stability of the NexION 5000 ICP-MS with challenging matrices. This is thanks to three stages of differential pumping and a design that minimizes surfaces prone to sample deposition and ion sputtering, such as those using extraction cones and lenses.

References

1. D.J. Douglas and J.B. French, An improved interface for inductively coupled plasma-mass spectrometry (ICP-MS), *Spectrochim. Acta*, 1986, 41B, 3, 197-204.
2. D.J. Douglas and J.B. French, Gas dynamics of inductively coupled plasma mass spectrometry interface, *J. Anal. At. Spectrom.*, 1988, 3, 743-747.
3. R. Campargue, High intensity supersonic molecular beam apparatus, *Rev. Sci. Instrum.*, 1964, 35, 111-112.
4. A. Kantrowitz, J. Grey, A high intensity source for the molecular beam. part i. theoretical, *Rev. Sci. Instrum.*, 1951, 22, 5, 328-332.
5. S.D. Tanner, Space charge in ICP-MS: calculations and implications, *Spectrochim. Acta*, 1992, 47B, 6, 809-823.
6. D.J. Douglas and S.D. Tanner, in *inductively coupled plasma mass spectrometry*, Ed. By A. Montaser, Wiley-VCH Inc., 1998, 656-666.
7. Y. Kishi and K. Kawabata, Effect of plasma parameters on the analysis of the semiconductor process, *Atom. Spectrosc.*, 2003, 24(2), 46-48.
8. H.R. Badiei, D. Bandura, V. Baranov, K. Kahen, and S.D. Tanner, US Pat. No. 9,105,457.
9. H.R. Badiei, S. Savtchenko, B. Atamanchuk, J. Larsen, D. Cheung, and P.B. Farnsworth, Developing new simulation strategies for ion motion with space charge, *Proceedings of the 67th ASMS Conference on Mass Spectrometry and Allied Topics*, Atlanta, GA, June 2-6, 2019.
10. T.N. Olney, W. Chen, and D.J. Douglas, Gas dynamics of the ICP-MS interface: impact pressure probe measurements of the gas flow profiles, *J. Anal. At. Spectrom.*, 1999, 14, 9-17.
11. P.B. Farnsworth, J. Larsen, H.R. Badiei, and S. Savtchenko, Experimental characterization of the ion beam produced by the triple-cone interface of a NexION 300S inductively coupled plasma mass spectrometer, *2018 Winter Conference on Plasma Spectrochemistry*, Amelia Island, Florida, Jan. 8-13, 2018.